

*A. PENDAHULUAN*

Energi dan Momentum gelombang elektromagnetik dibawa oleh medan listrik  $E$  dan medan magnet  $B$  yang menjalar melalui vakum.  
Sumber gelombangnya berupa muatan-muatan listrik yang berosilasi dalam atom, molekul, atau mungkin juga dalam suatu antena pemancar radio.  
Keterkaitan antara  $E$  dan  $B$  dituangkan dalam persamaan Maxwell yang mendasari teori medan magnetik.



*Dosen Mata Kuliah  
Andhy Setiawan, M.Si*



# Menu Utama



Pendahuluan



Persamaan Maxwell



Persamaan Gelombang Elektromagnetik



Transversalitas Gelombang Elektromagnetik



Vektor Poynting dan Kekekalan Energi



Gelombang Elektromagnetik dalam Medium



Gelombang dalam Medium Konduktif



Elektron bebas dalam Konduktor dan Plasma



Pemantulan dan Pembiasan Gelombang Elektromagnetik



Hukum Snellius



Persamaan Fresnel



Pandu Gelombang



Pandu Gelombang dengan Penampang Segi Empat



Pandu Gelombang Jalur Transmisi Koaksial

## A. PENDAHULUAN

Energi dan Momentum gelombang elektromagnetik dibawa oleh medan listrik  $E$  dan medan magnet  $B$  yang menjalar melalui vakum.

Sumber gelombangnya berupa muatan-muatan listrik yang berosilasi dalam atom, molekul, atau mungkin juga dalam suatu antena pemancar radio.

Untuk medan listrik  $E$  dan medan magnet  $B$  yang berubah dengan waktu, keberadaan  $E$  selalu disertai  $B$ , dan sebaliknya. Keterkaitan antara  $E$  dan  $B$  dituangkan dalam persamaan Maxwell yang mendasari teori medan magnetik.





## *B. PERSAMAAN MAXWELL*

Persamaan Maxwell dirumuskan dalam besaran medan listrik  $E$  dan medan magnet  $B$ . Seluruh persamaan Maxwell terdiri dari 4 persamaan medan, yang masing-masing dapat dipandang sebagai hubungan antara medan dan distribusi sumber, baik sumber muatan ataupun sumber arus.





## Persamaan-persamaan Maxwell

	<u>Medium</u>	<u>Vakum</u>
1.	$\nabla \cdot \vec{D} = \rho_b$	$\nabla \cdot E = 0$
2.	$\nabla \cdot B = 0$	$\nabla \cdot B = 0$
3.	$\nabla \times E = -\frac{\partial B}{\partial t}$	$\nabla \times E = -\frac{\partial B}{\partial t}$
4.	$\nabla \times H = \vec{J}_b + \frac{\partial \vec{D}}{\partial t}$	$\nabla \times B = \mu_o \epsilon_0 \frac{\partial E}{\partial t}$

*Click angka untuk mengetahui penurunan rumus masing-masing persamaan di atas*



**Persamaan Maxwell pertama** merupakan ungkapan dari

- hukum Gauss, yang menyatakan bahwa:

“ Jumlah garis gaya medan listrik yang menembus suatu permukaan tertutup, sebanding dengan jumlah muatan yang dilingkupi permukaan tersebut.”

Secara matematis Hukum Gauss dituliskan dengan:

$$\oint \vec{E} \cdot \hat{n} dA = \sum \frac{q}{\epsilon_0}$$

$$\oint \vec{E} \cdot \hat{n} dA = \frac{1}{\epsilon_0} \int dq$$

$$\oint \vec{E} \cdot \hat{n} dA = \frac{1}{\epsilon_0} \int \rho dV$$



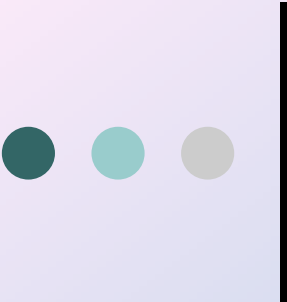

$$\oint \vec{E} \cdot \hat{n} dA = \frac{1}{\epsilon_0} \int (\rho_f + \rho_b) dV$$

$$\oint \vec{E} \cdot \hat{n} dA = \frac{1}{\epsilon_0} \int (-\nabla \cdot \vec{P} + \rho_b) dV$$

Dari teorema divergensi  $\oint \vec{E} \cdot \hat{n} dA = \int \nabla \cdot \vec{E} dV$

$$\int \nabla \cdot \vec{E} dV = \frac{1}{\epsilon_0} \int (-\nabla \cdot \vec{P} + \rho_b) dV$$

$$\int \left( \nabla \cdot \left( \vec{E} \epsilon_0 \right) + \nabla \cdot \vec{P} \right) dv = \int \rho_b dV$$

$$\epsilon_0 \vec{E} + \vec{P} = \epsilon \vec{E} = \vec{D}$$

$\nabla \cdot \vec{D} = \rho_b \longrightarrow$  Persamaan Maxwell (1) dalam Medium





Untuk ruang vakum, karena tidak ada sumber maka  $\rho = 0$  sehingga:

$$\nabla \cdot \vec{E} = \frac{\rho_b}{\epsilon_0}$$

$$\nabla \cdot \vec{E} = 0$$



Persamaan Maxwell (1) untuk ruang vakum,  
tanpa sumber muatan





- **Persamaan Maxwell kedua** merupakan Hukum Gauss magnetik, yang menyatakan "fluks medan magnetik yang menembus suatu permukaan tertutup sama dengan nol, tidak ada sumber medan berupa muatan magnetik." Atau dengan kata lain, "garis gaya medan magnet selalu tertutup, tidak ada muatan magnet monopole."

Melalui teorema Gauss, persamaan Maxwell kedua dapat dituliskan dalam bentuk integral:

$$\phi_B = \oint \vec{B} \cdot \hat{n} dA = 0$$

Dari teorema divergensi  $\oint \vec{B} \cdot \hat{n} dA = \oint \nabla \cdot \vec{B} dV$  maka

$$\oint \nabla \cdot \vec{B} dV = 0$$

$\nabla \cdot \vec{B} = 0$  Persamaan Maxwell (2) dalam medium dan vakum



**Persamaan Maxwell ketiga** merupakan ungkapan Hukum Faraday-Lenz, yang menyatakan bahwa "pengaruh medan magnet yang berubah dengan waktu."

Secara matematis dituliskan:

$$\varepsilon = -\frac{\partial \phi}{\partial t} \quad \text{dengan} \quad \phi = \oint \vec{B} \cdot \hat{n} dA$$

karena  $\varepsilon = \int \vec{E} \cdot d\vec{l}$  maka

$$\int \vec{E} \cdot d\vec{l} = -\frac{\partial}{\partial t} \int \vec{B} \cdot \hat{n} dA$$

Dari teorema Stokes  $\int \vec{E} \cdot d\vec{l} = \int \nabla_x \vec{E} \cdot \hat{n} dA$

$$\int \nabla_x \vec{E} \cdot \hat{n} dA = -\frac{\partial}{\partial t} \int \vec{B} \cdot \hat{n} dA$$

$$\nabla_x \vec{E} = -\frac{\partial \vec{B}}{\partial t}$$

Persamaan Maxwell (3) dalam medium  
Dan vakum.



*Persamaan Maxwell keempat* merupakan Hukum Ampere:



$$\oint \vec{B} \cdot d\vec{l} = \mu I \quad \text{dengan} \quad \frac{\vec{B}}{\mu} = \vec{H} \quad ; \quad I = \int \vec{J} \cdot \hat{n} dA$$

$$\oint \vec{H} \cdot d\vec{l} = I \quad \text{dan} \quad \vec{J} = \vec{J}_b + \vec{J}_f$$

$$\oint \vec{H} \cdot d\vec{l} = \int \left( \vec{J}_b + \vec{J}_f \right) \cdot \hat{n} \cdot dA$$

$$\oint (\nabla \times \vec{H}) \cdot \hat{n} \cdot dA = \int \left( \vec{J}_b + \varepsilon \frac{\partial \vec{E}}{\partial t} \right) \cdot \hat{n} \cdot dA$$

$$\nabla \times \vec{H} = \vec{J}_b + \varepsilon \frac{\partial \vec{E}}{\partial t}$$

$$\nabla \times \vec{H} = \vec{J}_b + \frac{\partial \vec{D}}{\partial t} \quad \text{Persamaan Maxwell (4) dalam medium}$$



Untuk persamaan Maxwell (4) dalam vakum, yaitu:

$$\oint \vec{B} \cdot d\vec{l} = \mu_0 I$$

Dari teorema Stokes  $\oint \vec{B} \cdot d\vec{l} = \int \nabla \times \vec{B} \cdot \hat{n} dA$  maka

$$\int \nabla \times \vec{B} \cdot \hat{n} dA = \mu_0 \int \vec{J} \cdot \hat{n} dA$$

$$\nabla \times \vec{B} = \mu_0 \vec{J}$$

$$\nabla \times \vec{B} = \mu_0 \epsilon_0 \frac{\partial \vec{E}}{\partial t} \longrightarrow \text{Persamaan Maxwell (4) dalam Vakum, Tanpa sumber muatan}$$



# B.1. PERSAMAAN GELOMBANG ELEKTROMAGNETIK

## MEDAN LISTRIK

Dari persamaan Maxwell (3):

$$\nabla \times \vec{E} = -\frac{\partial \vec{B}}{\partial t}$$

Ruas kanan dan ruas kiri dideferensialkan dengan operasi rotasi, maka:

$$\nabla \times \left( \nabla \times \vec{E} \right) = -\frac{\partial}{\partial t} \left( \nabla \times \vec{B} \right)$$

Dari vektor identitas

$$\nabla \times \left( \nabla \times \vec{E} \right) = \nabla \left( \nabla \cdot \vec{E} \right) - \nabla^2 \vec{E}$$

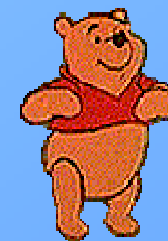

Maka:

$$\bullet \bullet \bullet \left| \nabla \left( \nabla \cdot \vec{E} \right) - \nabla^2 \vec{E} = -\frac{\partial}{\partial t} \left( \nabla \times \vec{B} \right) \right.$$

Dengan  $\nabla \cdot \vec{E} = 0$  dan  $\nabla \times \vec{B} = \mu_0 \epsilon_0 \frac{\partial \vec{E}}{\partial t}$  sehingga

$$-\nabla^2 \vec{E} = -\mu_0 \epsilon_0 \frac{\partial^2 \vec{E}}{\partial t^2}$$

$$\nabla^2 \vec{E} = \mu_0 \epsilon_0 \frac{\partial^2 \vec{E}}{\partial t^2} \qquad \nabla^2 \vec{E} - \mu_0 \epsilon_0 \frac{\partial^2 \vec{E}}{\partial t^2} = 0$$

$$\nabla^2 \vec{E} - \frac{1}{c^2} \frac{\partial^2 \vec{E}}{\partial t^2} = 0$$

dengan  $c = \frac{1}{\sqrt{\mu_0 \epsilon_0}}$



Sehingga persamaan gelombang medan listrik dalam bentuk diferensial:

$$\left[ \frac{\partial^2}{\partial x^2} + \frac{\partial^2}{\partial y^2} + \frac{\partial^2}{\partial z^2} - \frac{1}{c^2} \frac{\partial^2}{\partial t^2} \right] \vec{E}_x = 0$$

$$\left[ \frac{\partial^2}{\partial x^2} + \frac{\partial^2}{\partial y^2} + \frac{\partial^2}{\partial z^2} - \frac{1}{c^2} \frac{\partial^2}{\partial t^2} \right] \vec{E}_y = 0$$

$$\left[ \frac{\partial^2}{\partial x^2} + \frac{\partial^2}{\partial y^2} + \frac{\partial^2}{\partial z^2} - \frac{1}{c^2} \frac{\partial^2}{\partial t^2} \right] \vec{E}_z = 0$$

Solusi paling sederhana:

$$\vec{E}(z, t) = \vec{E}_0 \cos(kz - \omega t)$$



# MEDAN MAGNET

Dari persamaan Maxwell (4):

$$\nabla \times \vec{B} = \mu_0 \epsilon_0 \frac{\partial \vec{E}}{\partial t}$$

Dengan operasi rotasi:

$$\nabla \times \left( \nabla \times \vec{B} \right) = \mu_0 \epsilon_0 \frac{\partial (\nabla \times \vec{E})}{\partial t}$$

$$\nabla \left( \nabla \cdot \vec{B} \right) - \nabla^2 \vec{B} = \mu_0 \epsilon_0 \frac{\partial (\nabla \times \vec{E})}{\partial t}$$

Karena vektor identitas  $\nabla \times \left( \nabla \times \vec{B} \right) = \nabla \left( \nabla \cdot \vec{B} \right) - \nabla^2 \vec{B}$

Dan persamaan Maxwell (2) serta (3):

$$\nabla \cdot \vec{B} = 0 \quad \text{dan} \quad \nabla \times \vec{E} = -\frac{\partial \vec{B}}{\partial t}$$





sehingga

$$\nabla^2 \vec{B} = \mu_0 \epsilon_0 \frac{\partial^2 \vec{B}}{\partial t^2}$$

$$\nabla^2 \vec{B} = \frac{1}{c^2} \frac{\partial^2 \vec{B}}{\partial t^2}$$

$$\nabla^2 \vec{B} - \frac{1}{c^2} \frac{\partial^2 \vec{B}}{\partial t^2} = 0$$

Maka persamaan gelombang medan magnet dalam bentuk diferensial:

$$\left[ \frac{\partial^2}{\partial x^2} + \frac{\partial^2}{\partial y^2} + \frac{\partial^2}{\partial z^2} - \frac{1}{c^2} \frac{\partial^2}{\partial t^2} \right] \vec{B}_x = 0$$

$$\left[ \frac{\partial^2}{\partial x^2} + \frac{\partial^2}{\partial y^2} + \frac{\partial^2}{\partial z^2} - \frac{1}{c^2} \frac{\partial^2}{\partial t^2} \right] \vec{B}_y = 0$$





$$\left[ \frac{\partial^2}{\partial x^2} + \frac{\partial^2}{\partial y^2} + \frac{\partial^2}{\partial z^2} - \frac{1}{c^2} \frac{\partial^2}{\partial t^2} \right] \vec{B}_z = 0$$

Solusinya:  $\vec{B}(z, t) = \vec{B}_0 \cos(kz - \omega t)$

Solusi persamaan gelombang elektromagnet untuk medan Listrik dan medan magnet merupakan contoh eksplisit dari gelombang datar (Plan Wave)

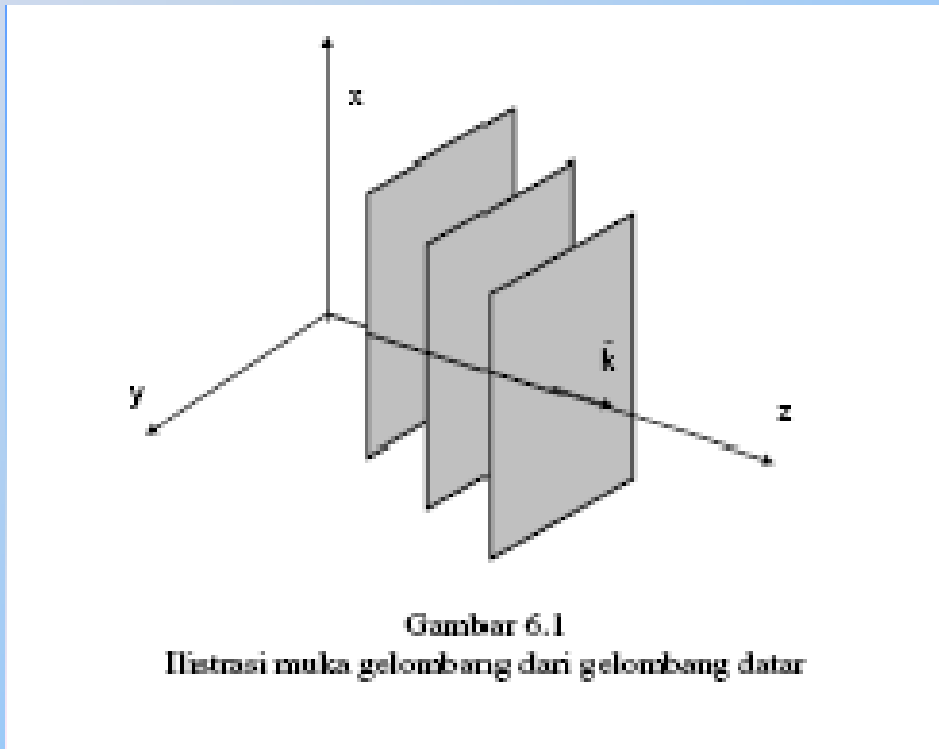

Gambar 6.1  
Ilustrasi muka gelombang dari gelombang datar

Bentuk umum:  $f(kz - \omega t)$

Kecepatan:  $v = \frac{\omega}{k}$

Bentuk muka gelombangnya tegak lurus vektor satuan  $\hat{k}$ , maka:

$$\hat{k} \cdot \vec{z} = \text{kons tan}$$



## Sifat-sifat gelombang datar:

1. Mempunyai arah jalar tertentu (dalam persamaan, arah  $z$ ).
2. Tidak mempunyai komponen pada arah rambat.
3. Tidak ada komponen  $E$  dan  $B$  yang bergantung pada koordinat transversal (pada contoh, koordinat transversalnya  $x$  dan  $y$ ).

Sehingga solusi persamaan gelombangnya menjadi:

$$\vec{E} = \hat{i} E_x(z, t) + \hat{j} E_y(z, t)$$

$$\vec{E} = \hat{j} E_y(x, t) + \hat{k} E_z(x, t)$$

$$\vec{B} = \hat{i} B_x(z, t) + \hat{j} B_y(z, t)$$

$$\vec{B} = \hat{j} B_y(x, t) + \hat{k} B_z(x, t)$$



## B.2. TRANSVERSALITAS GELOMBANG ELEKTROMAGNETIK

### MEDAN LISTRIK

Untuk membuktikan sifat dari gelombang datar yaitu transversalitas, dari persamaan Maxwell (1) dan (4):

$$\nabla \cdot \vec{E} = 0$$

$$\frac{\partial \vec{E}_x(z,t)}{\partial x} + \frac{\partial \vec{E}_y(z,t)}{\partial y} + \frac{\partial \vec{E}_z(z,t)}{\partial z} = 0$$

$$\frac{\partial \vec{E}_z(z,t)}{\partial z} = 0 \quad E_z \text{ tidak bergantung pada } z \text{ (sisi spatial)}$$

$$\nabla \times \vec{B} = \mu_0 \epsilon_0 \frac{\partial \vec{E}}{\partial t}$$

$$\frac{\partial \vec{B}_y}{\partial x} - \frac{\partial \vec{B}_z}{\partial y} = \mu_0 \epsilon_0 \frac{\partial \vec{E}_z}{\partial t} \quad \rightarrow \quad \frac{\partial E_z(z,t)}{\partial t} = 0 \quad \text{Sisi temporal}$$



Yang berarti  $E_z$  tidak bergantung pada  $t$

Jadi  $E_z(z,t) = \text{konstan} = 0$ , yang berarti arah getar dari gelombang medan listrik tegak lurus pada arah rambatnya, karena medan listrik  $E$  hanya mempunyai komponen-komponen pada arah yang tegak lurus pada arah rambat.

## MEDAN MAGNET

Dari persamaan Maxwell (2):

$$\nabla \cdot \vec{B} = 0$$

$$\frac{\partial \vec{B}_x(z,t)}{\partial x} + \frac{\partial \vec{B}_y(z,t)}{\partial y} + \frac{\partial \vec{B}_z(z,t)}{\partial z} = 0$$

$$\frac{\partial \vec{B}_z(z,t)}{\partial z} = 0 \text{ Sisi spatial, yang berarti } B_z \text{ tidak bergantung pada } z.$$



Dan dari persamaan Maxwell (3):

$$\nabla_x \vec{E} = -\frac{\partial \vec{B}}{\partial t}$$

$$\frac{\partial \vec{E}_y}{\partial x} - \frac{\partial \vec{E}_x}{\partial y} = \frac{\partial B_z(z, t)}{\partial t}$$

$$\frac{\partial B_z(z, t)}{\partial t} = 0 \quad \text{Sisi temporal, yang berarti } B_z \text{ tidak bergantung pada } t.$$

Yang berarti arah getar gelombang medan magnet tegak lurus terhadap arah rambatnya.

Dengan demikian maka gelombang Elektromagnetik merupakan gelombang transversal.



Hubungan E dan B, misal menjalar dalam arah z:

$$\vec{E} = \hat{i} E_x + \hat{j} E_y$$

$$\vec{E} = \hat{i} E_{0x} \cos(kz - \omega t) + \hat{j} E_{0y} \cos(kz - \omega t)$$

$$\vec{B} = \hat{i} B_x + \hat{j} B_y$$

$$\vec{B} = \hat{i} B_{0x} \cos(kz - \omega t) + \hat{j} B_{0y} \cos(kz - \omega t)$$

$$\nabla \times \vec{E} = -\frac{\partial \vec{B}}{\partial t}$$

$$k \sin(kz - \omega t) \left[ \hat{i} E_{0y} - \hat{j} E_{0x} \right] = -\omega \sin(kz - \omega t) \left[ \hat{i} B_{0x} + \hat{j} B_{0y} \right]$$

$$k \left[ \hat{i} E_{0y} - \hat{j} E_{0x} \right] = -\omega \left[ \hat{i} B_{0x} + \hat{j} B_{0y} \right]$$

$$-\left( \vec{k} \times \vec{E} \right) = -\omega \vec{B} \quad \Rightarrow \quad E = \frac{\omega}{k} B \quad \Rightarrow \quad E = cB$$

$\vec{E} \perp \vec{B}$



Hubungan vektor propogasi  $k$ , medan listrik  $E$ , dan medan magnet  $B$  ditunjukkan dengan gambar:

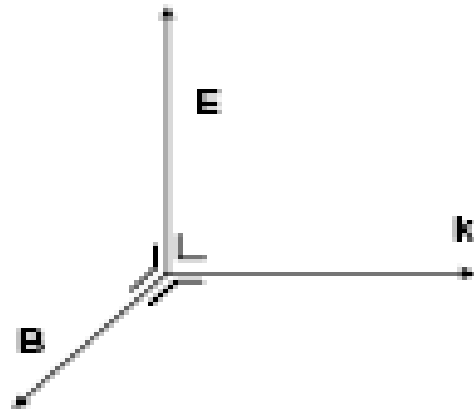

(a)

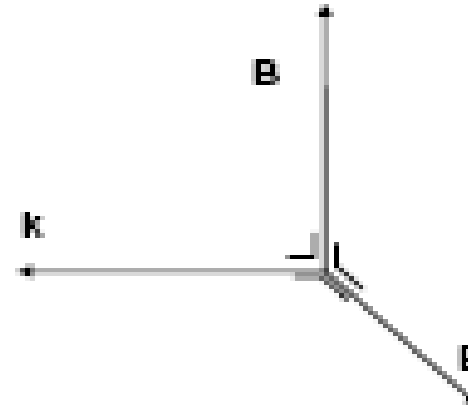

(b)





## B.3. VEKTOR POYNTING DAN KEKALKAN ENERGI

Energi medan elektromagnetik merupakan jumlah dari Energi Medan listrik dan energi medan magnet.

$$u = u_B + u_E$$

$$u = \frac{1}{2\mu_0} B^2 + \frac{1}{2} \epsilon_0 E^2$$

Laju perubahan rapat energi atau perubahan rapat energi terhadap waktu:

$$\frac{du}{dt} = \frac{1}{\mu_0} \vec{B} \cdot \frac{\partial \vec{B}}{\partial t} + \epsilon_0 \vec{E} \cdot \frac{\partial \vec{E}}{\partial t}$$

Dari persamaan Maxwell (3) dan (4), maka:

$$\nabla \times \vec{E} = -\frac{\partial \vec{B}}{\partial t} \quad \text{dan} \quad \nabla \times \vec{B} = \mu_0 \epsilon_0 \frac{\partial \vec{E}}{\partial t}$$



Sehingga



$$\frac{du}{dt} = \frac{1}{\mu_0} \vec{B} \cdot \left( -\nabla \times \vec{E} \right) + \frac{1}{\mu_0} \vec{E} \cdot \left( \nabla \times \vec{B} \right)$$

$$\frac{du}{dt} = -\frac{1}{\mu_0} \left[ \vec{B} \cdot \left( \nabla \times \vec{E} \right) - \vec{E} \cdot \left( \nabla \times \vec{B} \right) \right]$$

Dari vektor identitas

$$\nabla \cdot (\vec{E} \times \vec{B}) = \vec{B} \cdot (\nabla \times \vec{E}) - \vec{E} \cdot (\nabla \times \vec{B}) \quad \text{maka}$$

$$\frac{du}{dt} = -\frac{1}{\mu_0} \nabla \cdot (\vec{E} \times \vec{B}) \quad \longrightarrow \quad \frac{du}{dt} + \nabla \cdot \vec{S} = 0 \quad \text{Hukum Kekekalan Energi}$$

dengan  $\vec{S} = \frac{1}{\mu_0} (\vec{E} \times \vec{B})$  disebut vektor poynting

mengungkapkan besarnya energi persatuan waktu per satuan luas yang dibawa oleh medan elektromagnetik



# C. GELOMBANG ELEKTROMAGNETIK DALAM MEDIUM

Persamaan-persamaan Maxwell

$$\nabla \cdot D = \rho_b$$

$$\nabla \cdot B = 0$$

$$\nabla \times E = -\frac{\partial B}{\partial t}$$

$$\nabla \times H = J_b + \frac{\partial D}{\partial t}$$



## C. 1 GEM DALAM MEDIUM KONDUKTIF

Dalam medium konduktif yang bebas sumber, dan dari hubungan  $B = \mu H$  dan  $D = \epsilon E$ , persamaan Maxwell 4 dapat ditulis:

$$\nabla \times H = J_b + \frac{\partial D}{\partial t}$$

$$\nabla \times B = \mu J + \epsilon \mu \frac{\partial E}{\partial t}$$

$$\frac{\partial}{\partial t} (\nabla \times B) = \frac{\partial}{\partial t} (\mu J + \epsilon \mu \frac{\partial E}{\partial t}), \text{ dengan } \nabla \times E = -\frac{\partial B}{\partial t}$$

$$-\nabla \times (\nabla \times E) = \mu \frac{\partial J}{\partial t} + \mu \epsilon \frac{\partial^2 E}{\partial t^2},$$



$$\nabla \times (\nabla \times E) = \nabla(\nabla \cdot E) - \nabla^2 E \text{ dan } J = \sigma E$$

maka

$$-(\nabla(\nabla \cdot E) - \nabla^2 E) = \mu\sigma \frac{\partial E}{\partial t} + \mu\varepsilon \frac{\partial^2 E}{\partial t^2}$$

$$0 + \nabla^2 E = \mu\sigma \frac{\partial E}{\partial t} + \mu\varepsilon \frac{\partial^2 E}{\partial t^2}$$

$$\nabla^2 E - \mu\varepsilon \frac{\partial^2 E}{\partial t^2} - \mu\sigma \frac{\partial E}{\partial t} = 0$$

Dengan solusi :  $E(z, t) = E_0 \cos(\kappa z - \omega t)$

Atau dalam bentuk kompleks :

$$E(z, t) = E_0 e^{-i(\kappa z - \omega t)}$$



● ● ●

$$E(z, t) = E_0 e^{-i(\kappa z - \omega t)}$$

Sehingga :

$$\nabla^2 E - \mu\varepsilon \frac{\partial^2 E}{\partial t^2} - \mu\sigma \frac{\partial E}{\partial t} = 0$$

$$\nabla^2 E = \frac{\partial^2}{\partial z^2} (E_0 e^{-i(\kappa z - \omega t)}) = i^2 \kappa^2 E_0 e^{-i(\kappa z - \omega t)} = -\kappa^2 E$$

$$\frac{\partial E}{\partial t} = i\omega E_0 e^{-i(\kappa z - \omega t)} = i\omega E$$

$$\frac{\partial^2 E}{\partial t^2} = i^2 \omega^2 E_0 e^{-i(\kappa z - \omega t)} = -\omega^2 E$$

$$-\kappa^2 E + \mu\varepsilon\omega^2 E - \mu\sigma i\omega E = 0$$

$$\kappa^2 E - \mu\varepsilon\omega^2 E + \mu\sigma i\omega E = 0$$

$$\kappa^2 = \mu\varepsilon\omega^2 - i\mu\sigma\omega$$

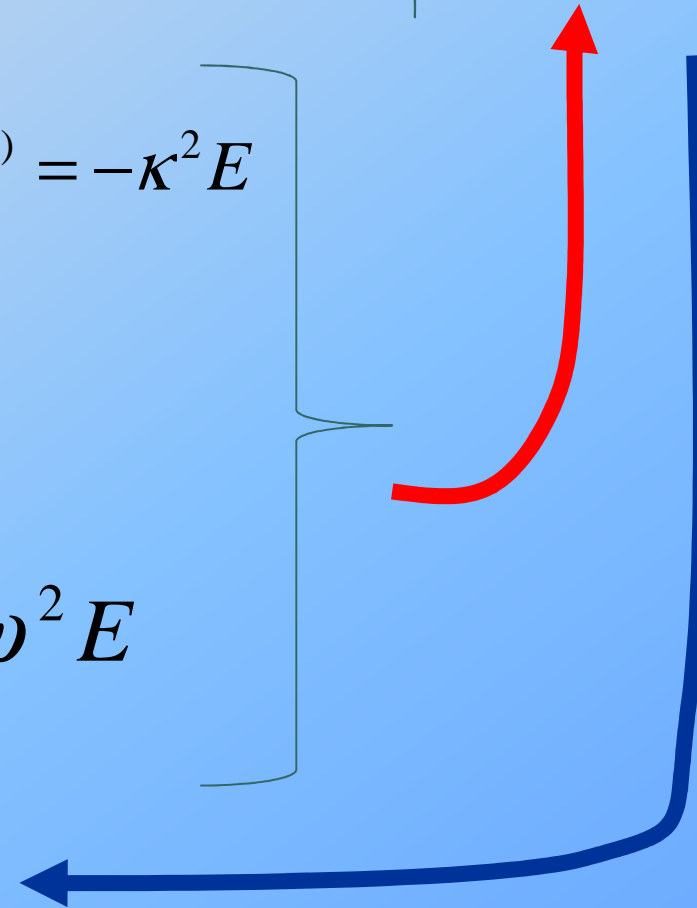

Misal :  $\kappa = a + ib$

$$\kappa^2 = (a + ib)^2 = a^2 - b^2 + 2abi$$

Dari pers  $\kappa^2 = \mu\epsilon\omega^2 - i\mu\sigma\omega$ , maka :

$$a^2 - b^2 = \mu\epsilon\omega^2 \quad \text{dan} \quad 2ab = -\mu\sigma\omega$$

$$a^2 - \left(-\frac{\mu\sigma\omega}{2a}\right)^2 = \mu\epsilon\omega^2 \quad b = -\frac{\mu\sigma\omega}{2a}$$

$$a^2 - \left(\frac{\mu\sigma\omega}{2a}\right)^2 = \mu\epsilon\omega^2 \longrightarrow \text{kalikan dengan } 4a^2$$

$$4(a^2)^2 - 4\mu\epsilon\omega^2 a^2 - (\mu\sigma\omega)^2 = 0$$

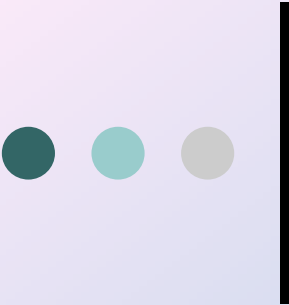

$$4(a^2)^2 - 4\mu\epsilon\omega^2 a^2 - (\mu\sigma\omega)^2 = 0$$

Dengan menggunakan rumus akar kuadrat, diperoleh :

$$(a_{1,2})^2 = \frac{4\mu\epsilon\omega^2 \pm \sqrt{(-4\mu\epsilon\omega^2)^2 + 4(4)(\mu\sigma\omega)^2}}{8}$$

$$(a_{1,2})^2 = \frac{\mu\epsilon\omega^2}{2} \pm \frac{1}{2} \sqrt{(\mu\epsilon\omega^2)^2 + (\mu\sigma\omega)^2}$$

$$(a_{1,2})^2 = \frac{1}{2} (\mu\epsilon\omega^2) \pm \frac{1}{2} \mu\omega \sqrt{\epsilon^2 \omega^2 + \sigma^2}$$

$$(a_{1,2})^2 = \frac{1}{2} (\mu\epsilon\omega^2) \pm \frac{1}{2} \mu\omega^2 \epsilon \sqrt{1 + \left(\frac{\sigma}{\epsilon\omega}\right)^2}$$





$$(a_{1,2})^2 = \frac{1}{2}(\mu\epsilon\omega^2) \pm \frac{1}{2}\mu\omega^2\epsilon\sqrt{1 + \left(\frac{\sigma}{\epsilon\omega}\right)^2}$$

$$(a_{1,2})^2 = \frac{1}{2}(\mu\epsilon\omega^2) \left[ 1 \pm \sqrt{1 + \left(\frac{\sigma}{\epsilon\omega}\right)^2} \right]$$

Karena  $a$  bilangan riil, maka  $a^2$  harus positif sehingga dipilih:

$$a^2 = \frac{1}{2}(\mu\epsilon\omega^2) \left[ 1 + \sqrt{1 + \left(\frac{\sigma}{\epsilon\omega}\right)^2} \right]$$

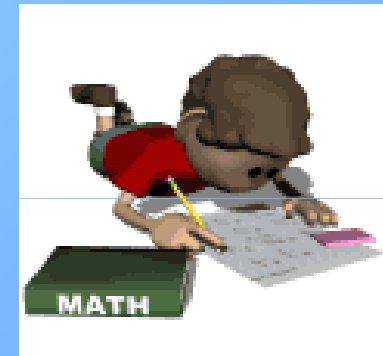



$$a^2 - b^2 = \mu\epsilon\omega^2$$

$$b^2 = a^2 - \mu\epsilon\omega^2$$

$$a^2 = \frac{1}{2}(\mu\epsilon\omega^2) \left[ 1 + \sqrt{1 + \left( \frac{\sigma}{\epsilon\omega} \right)^2} \right]$$

$$b^2 = \frac{1}{2}\mu\epsilon\omega^2 \left[ 1 + \sqrt{1 + \left( \frac{\sigma}{\epsilon\omega} \right)^2} \right] - \mu\epsilon\omega^2$$

$$b^2 = \mu\epsilon\omega^2 \left[ \frac{1}{2} + \frac{1}{2} \sqrt{1 + \left( \frac{\sigma}{\epsilon\omega} \right)^2} - 1 \right]$$

$$b^2 = \mu\epsilon\omega^2 \left[ -\frac{1}{2} + \frac{1}{2} \sqrt{1 + \left( \frac{\sigma}{\epsilon\omega} \right)^2} \right]$$

$$b^2 = \frac{\mu\epsilon\omega^2}{2} \left[ -1 + \sqrt{1 + \left( \frac{\sigma}{\epsilon\omega} \right)^2} \right]$$



## Besarnya bilangan gelombang

$$|\kappa|^2 = \kappa\kappa^* = (a+ib)(a-ib)$$

$$|\kappa|^2 = a^2 + b^2$$

$$|\kappa|^2 = \frac{1}{2}\mu\varepsilon\omega^2 \left[ 1 + \sqrt{1 + \left(\frac{\sigma}{\varepsilon\omega}\right)^2} \right] + \frac{1}{2}\mu\varepsilon\omega^2 \left[ -1 + \sqrt{1 + \left(\frac{\sigma}{\varepsilon\omega}\right)^2} \right]$$

$$|\kappa|^2 = \mu\varepsilon\omega^2 \sqrt{1 + \left(\frac{\sigma}{\varepsilon\omega}\right)^2}$$

$\kappa$  merupakan fungsi dari  $\omega$ . Dan karena  $\kappa$  berkaitan dengan cepat rambat, maka pada medium konduktif, cepat rambat gelombang bergantung pada frekuensi. Medium tersebut seperti medium dispersif.



● ● ● Untuk medium yang berkonduktivitas tinggi,  $\sigma \gg$   
maka

$$a^2 = \frac{1}{2} \mu \epsilon \omega^2 \left[ 1 + \sqrt{1 + \left( \frac{\sigma}{\epsilon \omega} \right)^2} \right]$$

$$a^2 = \frac{1}{2} \mu \epsilon \omega^2 \left[ 1 + \sqrt{\left( \frac{\sigma}{\epsilon \omega} \right)^2} \right]$$

$$a^2 = \frac{1}{2} \mu \epsilon \omega^2 \left( \frac{\sigma}{\epsilon \omega} \right)$$

$$a = \sqrt{\frac{\mu \sigma \omega}{2}}$$

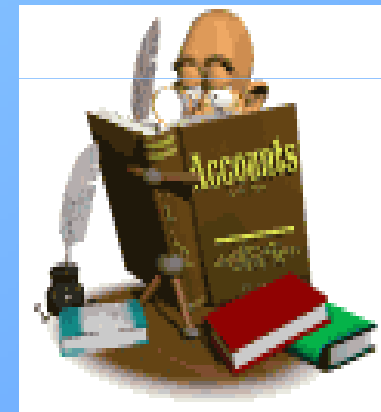

● ● ● | Sehingga :

$$b = -\frac{\mu\sigma\omega}{2a}$$

$$b = -\frac{\mu\sigma\omega}{2\sqrt{\frac{\mu\sigma\omega}{2}}}$$

$$b = -\sqrt{\frac{\mu\sigma\omega}{2}}$$

Jika  $\delta = \sqrt{\frac{2}{\mu\sigma\omega}}$  maka  $a = -b = \frac{1}{\delta}$

Dengan besaran  $\delta$  disebut tebal kulit (skin depth)



Jadi

$$k = a + ib = \frac{(1-i)}{\delta}$$

merupakan bilangan gelombang untuk medium dengan konduktivitas tinggi, pada frekuensi rendah maka solusinya :

$$E(z, t) = E_0 e^{-i[(a+ib)z - \omega t]}$$

$$E(z, t) = E_0 e^{-i\left[\left(\frac{1-i}{\delta}\right)z - \omega t\right]}$$

$$E(z, t) = E_0 e^{\frac{-z}{\delta}} e^{-i\left(\frac{z}{\delta} - \omega t\right)}$$



● ● ● Untuk medium yang konduktivitasnya rendah (konduktor buruk),  $\sigma$  jauh lebih kecil dari  $\omega\varepsilon$ . Maka Skin depthnya :

$$a^2 = \frac{\mu\varepsilon\omega^2}{2} \left[ 1 + \sqrt{1 + \left(\frac{\sigma}{\varepsilon\omega}\right)^2} \right]$$

Diuraikan dengan deret Maclaurin

$$(1+x)^n = 1 + nx + (n-1)\frac{x^2}{2!} + n(n-1)(n-2)\frac{x^3}{3!} + \dots$$



● ● ● | jika  $x = \left(\frac{\sigma}{\epsilon\omega}\right)^2$  maka :

$$(1+x)^{\frac{1}{2}} = 1 + \frac{1}{2}x + \frac{1}{2!} \cdot \frac{1}{2} \left(\frac{1}{2} - 1\right)x^2 + \dots$$

$$\left[1 + \left(\frac{\sigma}{\epsilon\omega}\right)^2\right]^{\frac{1}{2}} = 1 + \frac{1}{2} \left(\frac{\sigma}{\epsilon\omega}\right)^2 + \frac{1}{4} \left(-\frac{1}{2}\right) \left(\frac{\sigma}{\epsilon\omega}\right)^4 + \dots$$

$$\left[1 + \left(\frac{\sigma}{\epsilon\omega}\right)^2\right]^{\frac{1}{2}} = 1 + \frac{1}{2} \left(\frac{\sigma}{\epsilon\omega}\right)^2 - \dots$$

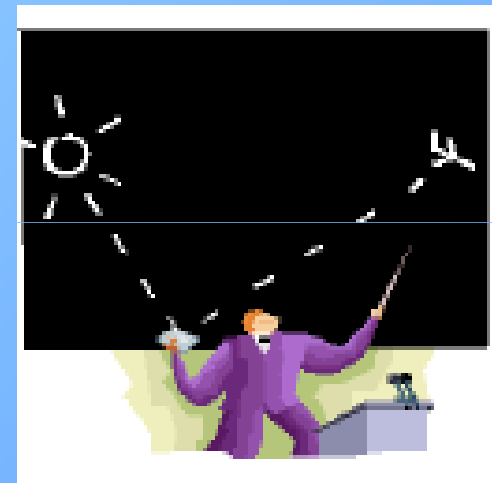





Jadi,

$$a^2 = \frac{\mu\epsilon\omega^2}{2} \left[ 1 + 1 + \frac{1}{2} \left( \frac{\sigma}{\epsilon\omega} \right)^2 \right] + \dots$$

$$a^2 = \frac{\mu\epsilon\omega^2}{2} \left[ 2 + \frac{1}{2} \left( \frac{\sigma}{\epsilon\omega} \right)^2 \right] + \dots$$

$$a^2 = \frac{\mu\sigma^2}{4\epsilon}$$

$$a = \sqrt{\frac{\mu\sigma^2}{4\epsilon}}$$

$$a = \frac{\sigma}{2} \sqrt{\frac{\mu}{\epsilon}}$$

$$a = -b = \frac{\sigma}{2} \sqrt{\frac{\mu}{\epsilon}}$$

dengan  $\delta = \frac{2}{\sigma} \sqrt{\frac{\epsilon}{\mu}}$

$$a = -b = \frac{1}{\delta}$$

yang disebut skin depth



● ● ● | Dari solusi persamaan gelombang pada medium konduktif yaitu :

$$E(z, t) = E_0 e^{-\frac{z}{\delta}} e^{-i(\frac{z}{\delta} - \omega t)}$$

yang dapat ditafsirkan setelah menempuh jarak sebesar  $\delta$ , maka amplitudo gelombang berkurang menjadi  $\frac{1}{e}$  dari amplitudo semula.

Jika  $z = \delta$  maka

$$E(z, t) = E_0 e^{-1} e^{-i(1 - \omega t)}$$

$$E(z, t) = \frac{E_0}{e} e^{-i(1 - \omega t)}$$





Medan Magnet :  $\mathbf{B} = \frac{\kappa}{\omega} \mathbf{E}$        $E(z, t) = E_0 e^{-i[(a+ib)z - \omega t]}$

$$B(z, t) = \frac{a + ib}{\omega} E_0 e^{-i[(a+ib)z - \omega t]}$$

Karena  $a + ib = r e^{-i\theta}$  dengan  $r = \sqrt{a^2 + b^2}$ , dan  $\theta = \tan^{-1}\left(\frac{b}{a}\right)$

maka

$$B(z, t) = \frac{\sqrt{a^2 + b^2}}{\omega} E_0 e^{-i[(a+ib)z - \omega t + \theta]}$$

Jadi medan listrik (E) dan medan magnet (B) tidak lagi mempunyai fase yang sama

## Kecepatan fase:

$$a^2 = \frac{\mu\epsilon\omega^2}{2} \left[ 1 + \sqrt{1 + \left(\frac{\sigma}{\epsilon\omega}\right)^2} \right]$$

$$a^2 = \frac{k^2}{2} \left[ 1 + \sqrt{1 + \left(\frac{\sigma}{\epsilon\omega}\right)^2} \right]$$

$$a = \frac{k}{\sqrt{2}} \left[ 1 + \sqrt{1 + \left(\frac{\sigma}{\epsilon\omega}\right)^2} \right]^{\frac{1}{2}}$$

dengan  $k v = \omega$ , dan karena  $a > k$ , maka kecepatan fase pada medium konduktif  $< v$  di udara/non konduktif



Besarnya vektor poynting untuk medium konduktif, yaitu :

$$S = \frac{1}{\mu} (\vec{E} \times \vec{B}) \quad \text{dengan} \quad B = \frac{\kappa}{\omega} E$$

$$S = \frac{1}{\mu} \left[ E \left( \frac{\kappa}{\omega} E \right) \right]$$

$$S = \frac{1}{\mu\omega} \kappa E^2$$

$$S = \frac{1}{\mu\omega} (a + ib) E_0^2 e^{-2i(\kappa z - \omega t)}$$



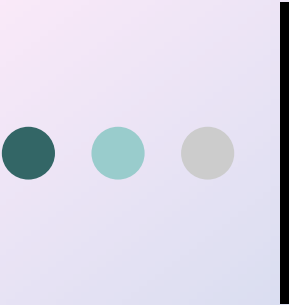

$$S = \frac{(a + ib)^2}{\mu\omega} E_0^2 e^{-2i[(a+ib)z - \omega t]}$$

$$S = \left[ \frac{\sqrt{a^2 + b^2}}{\mu\omega} \right] E_0^2 e^{-2i \left[ (a+ib)z - \omega t + \frac{\theta}{2} \right]}$$

Untuk medium konduktif  $a = -b = \frac{1}{\delta}$

maka

$$S = \left[ \frac{\sqrt{a^2 + b^2}}{\mu\omega} \right] E_0^2 e^{-2\frac{z}{\delta}} e^{-2i \left[ \frac{z}{\delta} - \omega t + \frac{\theta}{2} \right]}$$

Faktor  $e^{-2\frac{z}{\delta}}$

merupakan faktor redaman dalam perambatan energi.



## C. 2 ELEKTRON BEBAS DI DALAM KONDUKTOR DAN PLASMA

Elektron bebas di dalam konduktor tidak terikat pada atom dan molekul sehingga dapat digunakan persamaan Maxwell 3, yaitu :

$$\nabla \times E = -\frac{\partial B}{\partial t}$$

$$-\nabla^2 E = -\mu_0 \epsilon_0 \frac{\partial^2 E}{\partial t^2} - \mu_0 \frac{\partial J}{\partial t}$$

$$\nabla^2 E - \mu_0 \epsilon_0 \frac{\partial^2 E}{\partial t^2} - \mu_0 \frac{\partial J}{\partial t} = 0 \quad (1)$$



Gerakan elektron :

$$m \frac{dv}{dt} = q_e E \quad \text{dengan } v = \text{kecepatan elektron}$$

Ruas kiri dan ruas kanan dikalikan dengan  $Nq_e$

$$m \frac{\partial(vq_e N)}{\partial t} = N(q_e)^2 E \quad \text{dan } J = vq_e N, \text{ maka :}$$

$$m \frac{\partial J}{\partial t} = N(q_e)^2 E \dots\dots\dots(2)$$

Substitusi persamaan (2) ke persamaan (1)

$$\nabla^2 E - \mu_0 \epsilon_0 \frac{\partial^2 E}{\partial t^2} - \mu_0 \frac{(Nq_e^2)}{m} E = 0$$





● ● ● | Sehingga :

$$\nabla^2 E - \mu_0 \epsilon_0 \frac{\partial^2 E}{\partial t^2} - \mu_0 \frac{N(q_e)^2}{m} E = 0$$

dan  $E(z, t) = E_0 e^{-i(kz - \omega t)}$

$$\nabla^2 E = i^2 k^2 E_0 e^{-i(kz - \omega t)} = -k^2 E$$

$$\frac{\partial E}{\partial t} = i \omega E_0 e^{-i(kz - \omega t)} = i \omega E$$

maka,

$$\frac{\partial^2 E}{\partial t^2} = i^2 \omega^2 E_0 e^{-i(kz - \omega t)} = -\omega^2 E$$

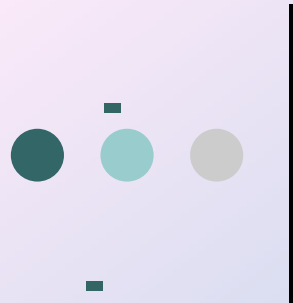

$$-k^2 E + \mu_0 \epsilon_0 (\omega^2 E) - \mu_0 \frac{N(q_e)^2}{m} E = 0$$

$$k^2 = \mu_0 \epsilon_0 \omega^2 - \mu_0 \frac{N(q_e)^2}{m}$$

$$\frac{k^2}{\mu_0 \epsilon_0 \omega^2} = 1 - \frac{N(q_e)^2}{\epsilon_0 m \omega^2}$$

$$\frac{1}{\mu_0 \epsilon_0} \frac{k^2}{\omega^2} = 1 - \frac{N(q_e)^2}{\epsilon_0 m \omega^2} \quad \text{dengan} \quad \frac{N(q_e)^2}{\epsilon_0 m} = \omega_p^2$$

karena  $c^2 = \frac{1}{\mu_0 \epsilon_0}$  dan  $\frac{k^2}{\omega^2} = \frac{1}{v^2}$

maka  $\frac{c^2}{v^2} = \left( 1 - \frac{\omega_p^2}{\omega^2} \right)$





Berdasarkan definisi indeks bias :  $n = \frac{c}{v}$

$$n^2 = \left( 1 - \frac{\omega_p^2}{\omega^2} \right)$$

$$n = \sqrt{1 - \frac{\omega_p^2}{\omega^2}}$$



*Indeks Bias Plasma*



● ● ●

Bila  $\omega < \omega_p$  maka nilai indeks bias  $n$  berupa **bilangan imajiner** yang berarti gelombang di dalam plasma tsb akan teredam.

Bila  $\omega \geq \omega_p$ , maka nilai indeks bias  $n$  berupa **bilangan nyata (real)** sehingga gelombang akan diteruskan.



# D. PEMANTULAN DAN PEMBIASAN GELOMBANG ELEKTROMAGNETIK

## D.1 HUKUM SNELLIUS

Tinjau untuk kasus Transverse Electric (TE)

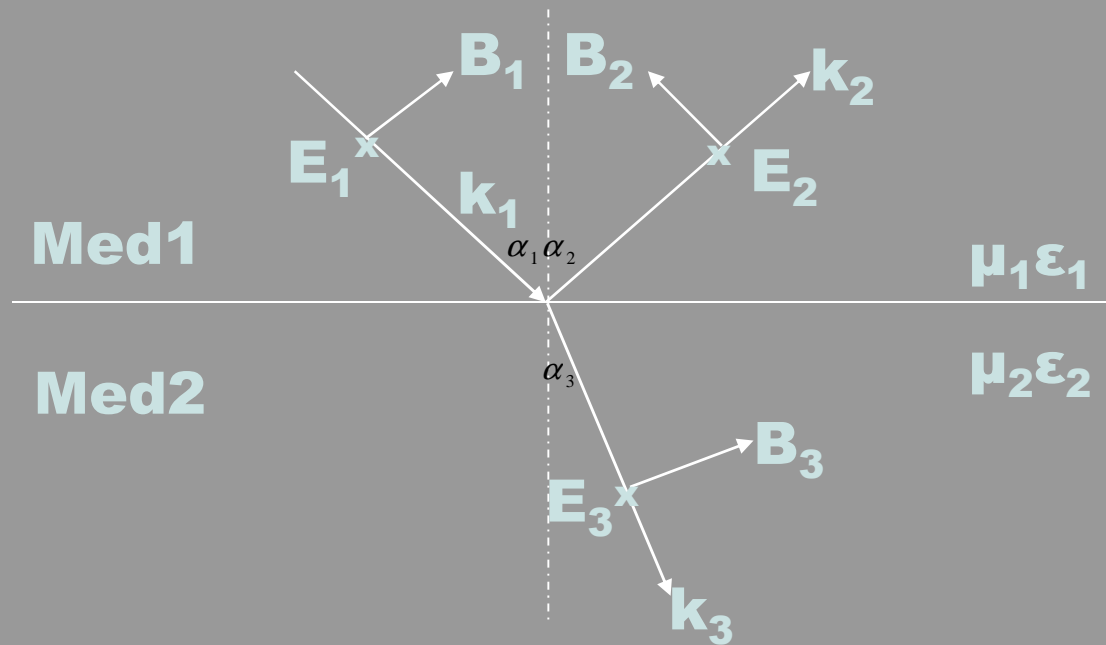

● ● ●  
Dari gambar tersebut diperoleh persamaan untuk gelombang medan magnet

$$B_1(r, t) = B_{01} \cos(k_1 \cdot r - \omega t) = B_{01} e^{i(k_1 \cdot r - \omega t)}$$

$$B_2(r, t) = B_{02} \cos(k_2 \cdot r - \omega t) = B_{02} e^{i(k_2 \cdot r - \omega t)}$$

Persamaan 1

$$B_3(r, t) = B_{03} \cos(k_3 \cdot r - \omega t) = B_{03} e^{i(k_3 \cdot r - \omega t)}$$

dengan

$$k_1 = k_1 [i \sin(\alpha_1) - j \cos(\alpha_1)]$$

$$k_2 = k_2 [i \sin(\alpha_2) + j \cos(\alpha_2)]$$

Persamaan 2

$$k_3 = k_3 [i \sin(\alpha_3) - j \cos(\alpha_3)]$$



● ● ● | Substitusi persamaan 1 ke persamaan 2:

$$B_1(r, t) = B_{01} e^{i[k_1(x \sin \alpha_1) - (y \cos \alpha_1) - \omega t]}$$

$$B_2(r, t) = B_{02} e^{i[k_2(x \sin \alpha_2) + (y \cos \alpha_2) - \omega t]} \quad \text{Persamaan 3}$$

$$B_3(r, t) = B_{03} e^{i[k_3(x \sin \alpha_3) - (y \cos \alpha_3) - \omega t]}$$

Syarat batas di  $y = 0$  ; maka

$$B_{1x} - B_{2x} = B_{3x}$$

$$B_1 \cos \alpha_1 - B_2 \cos \alpha_2 = B_3 \cos \alpha_3$$

Dan persamaan 3 menjadi :

$$B_{01} \cos \alpha_1 \cdot e^{i(k_1 x \sin \alpha_1)} - B_{02} \cos \alpha_2 \cdot e^{i(k_2 x \sin \alpha_2)} = B_{03} \cos \alpha_3 \cdot e^{i(k_3 x \sin \alpha_3)}$$



## Persamaan

$$B_{01} \cos \alpha_1 \cdot e^{i(k_1 x \sin \alpha_1)} - B_{02} \cos \alpha_2 \cdot e^{i(k_2 x \sin \alpha_2)} = B_{03} \cos \alpha_3 \cdot e^{i(k_3 x \sin \alpha_3)}$$

dapat dipandang sebagai  $Ae^{ax} + Be^{bx} = Ce^{cx}$

dengan menggunakan deret eksponensial:

$$A \left[ 1 + ax + \frac{a^2 x^2}{2!} + \dots \right] + B \left[ 1 + bx + \frac{b^2 x^2}{2!} + \dots \right] + C \left[ 1 + cx + \frac{c^2 x^2}{2!} + \dots \right]$$

dengan mengabaikan suku ke tiga, diperoleh :

$$A + B = C$$

$$Aax + Bbx = Ccx$$

$$Aax + Bbx = (A + B) cx$$





Dalam bentuk matriks :

$$\begin{bmatrix} A & B \end{bmatrix} \begin{bmatrix} ax \\ bx \end{bmatrix} = \begin{bmatrix} A & B \end{bmatrix} \begin{bmatrix} cx \\ cx \end{bmatrix}$$

diperoleh  $a = b = c$

maka  $k_1 \sin \alpha_1 = k_2 \sin \alpha_2$

Karena gelombang datang dan gelombang pantul berada dalam medium yang sama yaitu medium 1

maka :  $k_1 = k_2$

sehingga  $\alpha_1 = \alpha_2$

Dari  $a = c$  maka  $k_1 \sin \alpha_1 = k_3 \sin \alpha_3$





$$k = \frac{\omega}{v} \Rightarrow n = \frac{c}{v} \Rightarrow v = \frac{c}{n}$$

$$k = \frac{\omega}{\frac{c}{n}} = \frac{\omega n}{c} \Rightarrow k \approx n$$

maka  $k_1$  dan  $k_3$  sebanding dengan  $n_1$  dan  $n_3$

sehingga  $n_1 \sin \alpha_1 = n_2 \sin \alpha_3$



**Persamaan Snellius**



## D.2. PERSAMAAN FRESNEL

Setelah memahami tentang hukum Snellius, selanjutnya akan ditunjukkan perbandingan Amplitudo gelombang pantul dan gelombang bias terhadap amplitudo gelombang datang yang disebut dengan persamaan Fresnell

Kasus Transverse Magnetik (TM)

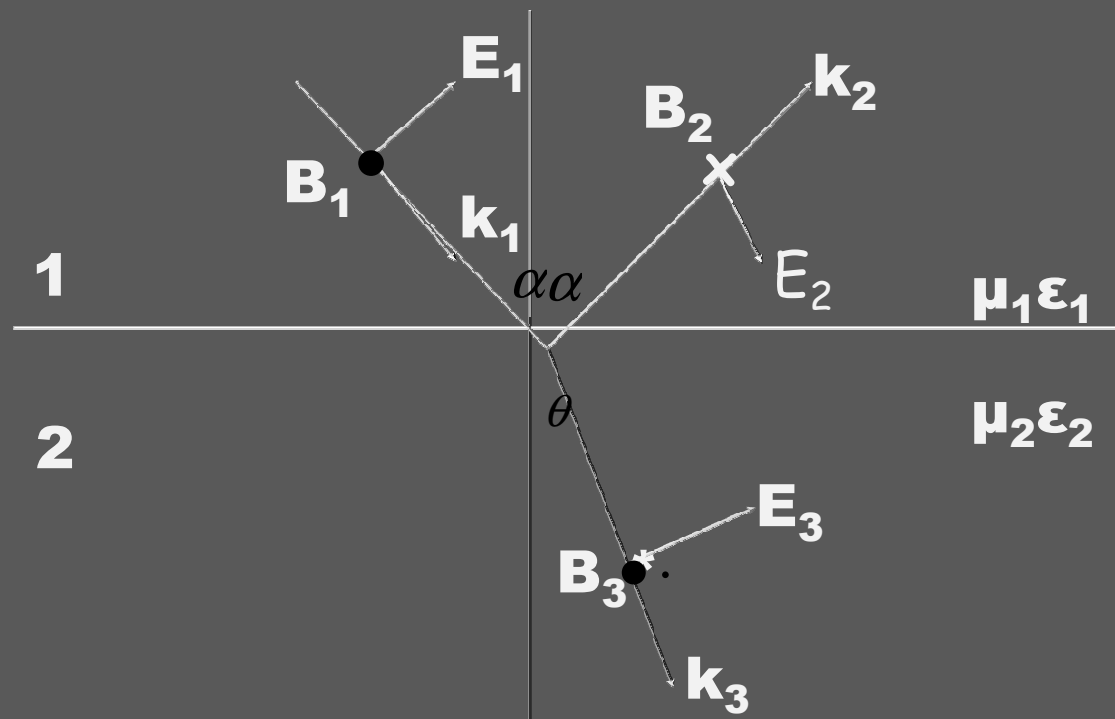

Dengan memasukkan batas di  $y = 0$  (berdasarkan gambar)

● ● ● Untuk medan listrik :

$$E_{1x} + E_{2x} = E_{3x}$$

$$(E_1 + E_2) \cos(\alpha) = E_3 \cos(\theta) \quad \dots\dots\dots 1$$

Untuk medan magnet :

$$B_1 - B_2 = B_3$$

Dengan  $B=E/c$  di Vakum atau  $B= E/v$  di medium

sehingga  $\frac{1}{v_1}(E_1 - E_2) = \frac{1}{v_2} E_3$  dan  $n=c/v$  maka  $1/v \sim n$

$$\text{maka} \quad n_1 (E_1 - E_2) = n_2 E_3 \quad \dots\dots\dots 2.1$$

$$E_3 = \frac{n_1 (E_1 - E_2)}{n_2} \quad \dots\dots\dots 2.2$$



Persamaan 2.2 disubstitusikan kedalam persamaan 1, maka akan diperoleh :

$$(E_1 + E_2) \cos(\alpha) = \frac{n_1}{n_2} (E_1 - E_2) \cos(\theta)$$

$$E_2 \left( \cos(\alpha) + \frac{n_1}{n_2} \cos(\theta) \right) = E_1 \left( \frac{n_1}{n_2} \cos(\theta) - \cos(\alpha) \right)$$

Maka diperoleh koefisien refleksi yaitu perbandingan antara medan pantul terhadap medan datang ( $E_2/E_1$ ).

$$r_{TM} = \frac{E_2}{E_1} = \frac{\frac{n_1}{n_2} \cos(\theta) - \cos(\alpha)}{\frac{n_1}{n_2} \cos(\theta) + \cos(\alpha)} \quad \text{dikali } n_2$$

maka

$$r_{TM} = \frac{E_2}{E_1} = \frac{n_1 \cos(\theta) - n_2 \cos(\alpha)}{n_1 \cos(\theta) + n_2 \cos(\alpha)} \quad \dots\dots 3$$



Dari persamaan 2.1 kita peroleh persamaan

$$n_1 (E_1 - E_2) = n_2 E_3$$

$$E_2 = \frac{n_1 E_1 - n_2 E_3}{n_1} \quad \dots\dots 4$$

Persamaan 4 disubstitusikan ke persamaan 1, maka :

$$\left( E_1 + \frac{n_1 E_1 - n_2 E_3}{n_1} \right) \cos(\alpha) = E_3 \cos(\theta)$$

$$2E_1 \cos(\alpha) - \frac{n_2}{n_1} E_3 \cos(\alpha) = E_3 \cos(\theta) \quad \Rightarrow \quad \text{dikali } n_1$$

maka

$$2n_1 E_1 \cos(\alpha) - n_2 E_3 \cos(\alpha) = n_1 E_3 \cos(\theta)$$

$$2n_1 E_1 \cos(\alpha) = E_3 (n_1 \cos(\theta) + n_2 \cos(\alpha))$$

Dari persamaan diatas dapat dicari koefisien transmisi,  
Yaitu perbandingan antara  $E_3/E_1$

$$t_{TM} = \frac{E_3}{E_1} = \frac{2n_1 \cos(\alpha)}{n_1 \cos(\theta) + n_2 \cos(\alpha)}$$



# Kasus Transver Elektrik (TE)

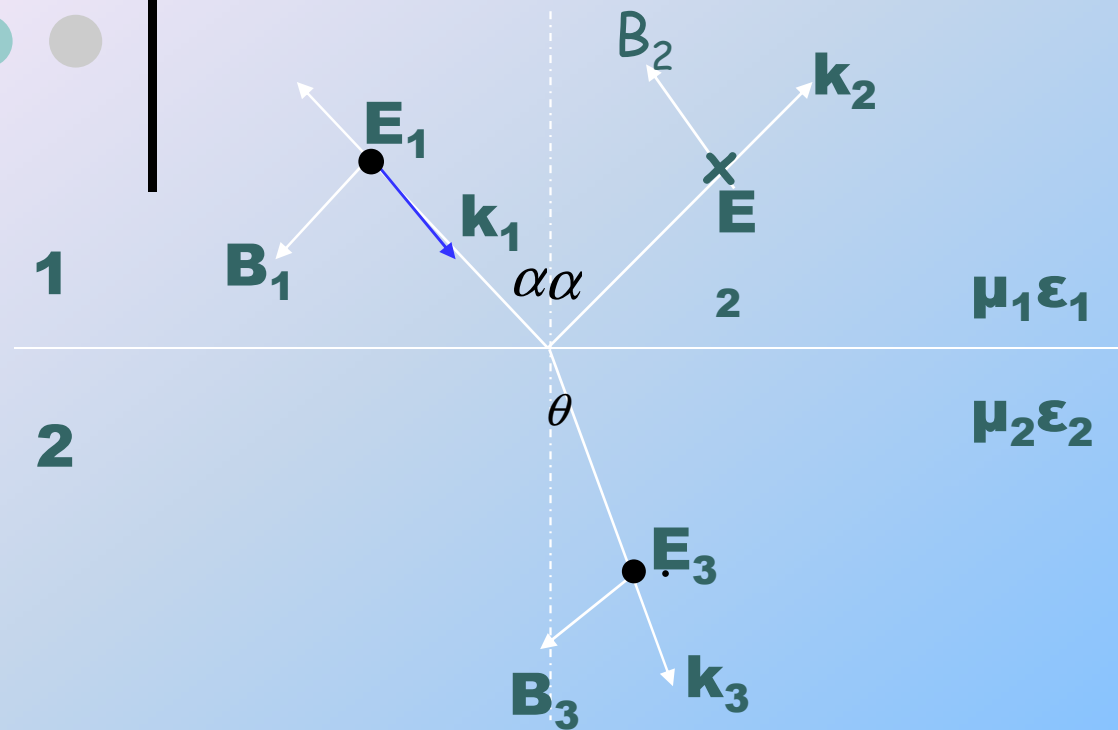

Berdasarkan gambar diatas apabila digunakan syarat batas di  $y=0$  Maka akan diperoleh hubungan :

Untuk meda magnet

$$B_{1x} - B_{2x} = B_{3x}$$

$$(B_1 - B_2) \cos \alpha = B_3 \cos \theta \quad \dots\dots\dots 1$$



Untuk medan listrik

$$E_1 + E_2 = E_3$$

Dari hubungan  $B = \frac{\kappa}{\omega} E$  ;  $E = \frac{\omega}{\kappa} B$  ;  $v = \frac{\omega}{\kappa}$  ;  $n = \frac{c}{v}$

maka  $E_1 + E_2 = E_3$

$$v_1(B_1 + B_2) = v_2 B_3 \quad v \sim 1/n$$

$$\frac{1}{n_1}(B_1 + B_2) = \frac{1}{n_2} B_3 \quad \dots\dots 2.1$$

$$B_3 = \frac{n_2}{n_1}(B_1 + B_2) \quad \dots\dots 2.2$$





Persamaan 2.2 disubstitusikan ke persamaan 1  
Sehingga diperoleh :

$$(B_1 - B_2)\cos\alpha = \frac{n_2}{n_1}(B_1 + B_2)\cos\theta$$

$$-B_2\left(\cos\alpha + \frac{n_2}{n_1}\cos\theta\right) = B_1\left(\frac{n_2}{n_1}\right)\cos\theta - \cos\alpha$$

maka  $R_{TE} = -\frac{B_2}{B_1} = \frac{\frac{n_2}{n_1}\cos\theta - \cos\alpha}{\cos\alpha + \frac{n_2}{n_1}\cos\theta}$

$$r_{TE} = \frac{B_2}{B_1} = \frac{\cos\alpha - \frac{n_2}{n_1}\cos\theta}{\cos\alpha + \frac{n_2}{n_1}\cos\theta} \implies r_{TE} = \frac{n_1\cos\alpha - n_2\cos\theta}{n_1\cos\alpha + n_2\cos\theta}$$



Dari persamaan 2.1 kita peroleh

$$\frac{1}{n}(B_1 + B_2) = \frac{1}{n_2} B_3$$

$$B_2 = \frac{n_1}{n_2} B_3 - B_1 \quad \text{..... 3}$$

Persamaan 3 disubstitusikan ke persamaan 1

$$\left( B_1 - \left( \frac{n_1}{n_2} B_3 - B_1 \right) \cos \alpha \right) = B_3 \cos \theta$$

$$2B_1 \cos \alpha - \frac{n_1}{n_2} B_3 \cos \alpha = B_3 \cos \theta$$

$$2n_2 \cos B_1 \cos \alpha = B_3 (n_1 \cos \alpha + n_2 \cos \theta)$$

$$t_{TE} = \frac{B_3}{B_1} = \frac{2n_2 \cos \alpha}{n_1 \cos \alpha + n_2 \cos \theta}$$



Apabila sudut bias  $90^\circ$  maka,

Dari hukum Snellius diperoleh hubungan

$$n_1 \sin \alpha_1 = n_2 \sin \alpha_3$$

$$n_1 \sin \alpha_1 = n_2 \sin 90^\circ$$

$$\sin \alpha_1 = \frac{n_2}{n_1} \quad \text{maka } n_1 > n_2$$

sudut kritis

Sudut datang yang menghasilkan sudut bias  $90^\circ$

Bila sudut datang lebih besar dari sudut kritis,  
maka terjadi pemantulan total.





Apabila  $\alpha + \theta = 90^\circ$

dari hukum Snellius diperoleh hubungan:

$$n_1 \sin \alpha = n_2 \sin \theta$$

$$n_1 \sin \alpha = n_2 \sin(90^\circ - \alpha)$$

$$\sin \alpha = \frac{n_2}{n_1} \cos \alpha$$

$$\tan(\alpha) = \frac{n_2}{n_1}$$

Sudut Brewster

Sudut datang yang menghasilkan  $\alpha + \theta = 90^\circ$



## E. PANDU GELOMBANG

Selubung konduktor kosong yang ujung-ujungnya dibatasi oleh permukaan disebut rongga (cavity). Sedangkan bila ujung-ujungnya tidak dibatasi oleh permukaan disebut dengan pandu gelombang

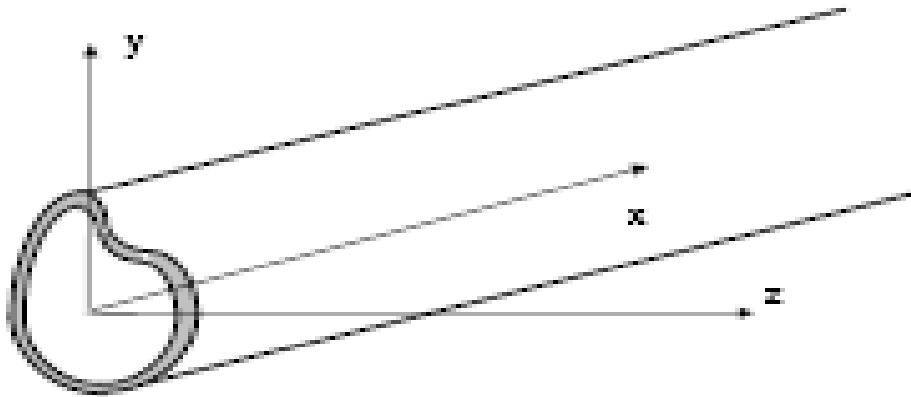

Gambar 6.6  
Pandu Gelombang



Diasumsikan bahwa pandu gelombang benar-benar konduktor sempurna, Sehingga bahan material tersebut berlaku  $E = 0$  Dan  $B = 0$

Misalkan gelombang elektromagnetik merambat dengan Bentuk fungsi sebagai berikut :

$$\begin{aligned} E(x, y, z, t) &= E_o(y, z)e^{i(kx - \omega t)} \\ B(x, y, z, t) &= B_o(y, z)e^{i(kx - \omega t)} \end{aligned} \quad \text{..... 1}$$

Persamaan ini disubstitusikan ke dalam persamaan Maxwell 3 dan 4 ,Maka akan diperoleh :

$$\frac{\partial E_z}{\partial z} - \frac{\partial E_y}{\partial z} = i\omega B_x \quad \text{..... 2.1}$$

$$\frac{\partial E_x}{\partial y} - ikE_y = -i\omega B_z \quad \text{..... 2.3}$$

$$\frac{\partial E_x}{\partial z} - ikE_z = i\omega B_y \quad \text{..... 2.2}$$

$$\frac{\partial B_z}{\partial y} - \frac{\partial B_y}{\partial z} = -\frac{i\omega}{c^2} E_x \quad \text{..... 2.4}$$





$$\left| \begin{array}{l} \frac{\partial B_x}{\partial z} - ikB_z = -\frac{i\omega}{c^2} E_y \quad \dots\dots 2.5 \\ \frac{\partial B_x}{\partial y} - ikB_y = \frac{i\omega}{c^2} E_z \quad \dots\dots 2.6 \end{array} \right.$$

Dari persamaan 2.1, 2.2, 2.3, 2.4, 2.5, 2.6, akan menghasilkan Solusi Untuk  $E_y$ ,  $E_z$ ,  $B_y$ , dan  $B_z$  sebagai berikut

$$E_y = \frac{i}{\left(\frac{\omega}{c^2}\right) - k^2} \left( k \frac{\partial E_x}{\partial y} + \omega \frac{\partial B_x}{\partial z} \right) \dots\dots 3.1$$

$$E_z = \frac{i}{\left(\frac{\omega}{c^2}\right) - k^2} \left( k \frac{\partial E_x}{\partial z} - \omega \frac{\partial B_x}{\partial y} \right) \dots\dots 3.2$$

$$B_y = \frac{i}{\left(\frac{\omega}{c^2}\right) - k^2} \left( k \frac{\partial B_x}{\partial y} - \frac{\omega}{c^2} \frac{\partial E_x}{\partial z} \right) \dots\dots 3.3$$

$$B_z = \frac{i}{\left(\frac{\omega}{c^2}\right) - k^2} \left( k \frac{\partial B_x}{\partial z} + \frac{\omega}{c^2} \frac{\partial E_x}{\partial y} \right) \dots\dots 3.4$$



Dari persamaan 3 tampak bahwa bila komponen Longitudinal  $E_x$  dan  $B_x$  diketahui, maka komponen lainnya dapat diketahui.

Dengan mensubstitusikan persamaan 3 ke dalam Persamaan Maxwell, kita akan peroleh persamaan Differensial dari komponen longitudinal sebagai Berikut :

$$\left[ \frac{\partial^2}{\partial y^2} + \frac{\partial^2}{\partial z^2} + \left( \frac{\omega}{c} \right)^2 - k^2 \right] E_x = 0 \quad \dots\dots 4.1$$

$$\left[ \frac{\partial^2}{\partial y^2} + \frac{\partial^2}{\partial z^2} + \left( \frac{\omega}{c} \right)^2 - k^2 \right] B_x = 0 \quad \dots\dots 4.2$$

Dengan menggunakan syarat batas pada permukaan konduktor sempurna, yaitu :

$$\hat{n} \cdot B = 0 \quad \hat{n} \times B = 0 \quad \dots\dots 5$$





Dengan  $\hat{n}$  adalah vektor satuan normal pada konduktor, maka akan kita peroleh

$$E_x = 0 \quad \text{Di permukaan} \quad \dots\dots 6.1$$

$$\frac{\partial B_x}{\partial n} = 0 \quad \text{Di permukaan} \quad \dots\dots 6.2$$

Bila  $E_x = 0$ , disebut gelombang TE (Transverse elektrik)

Bila  $B_x = 0$ , disebut gelombang TM (Transverse MAgnetik),

Dan  $E_x = 0$  dan  $B_x = 0$ , disebut gelombang TEM (Transverse Electric Magnetik)

Pada pandu gelombang yang terselubung, kasus TEM tidak pernah terjadi hal ini dapat ditunjukkan sebagai berikut :

Bila  $E_x = 0$ , maka menurut hukum gauss haruslah berlaku hukum

$$\frac{\partial E_y}{\partial y} + \frac{\partial E_z}{\partial z} = 0 \quad \dots\dots 7$$



● ● ● Dan bila  $B_x = 0$ , maka menurut hukum Faraday Berlaku hubungan

$$\frac{\partial E_x}{\partial y} - \frac{\partial E_y}{\partial z} = 0 \quad \dots\dots\dots 8$$

Karena  $E = 0$  di permukaan logam, maka potensial listrik  $V = \text{konstan}$  pada permukaan logam. Menurut hukum Gauss Atau persamaan Laplace untuk  $V$ , berlaku pula  $V = \text{konstan}$  Didalam rongga. Ini berarti  $E = 0$  didalam rongga. Dari Persamaan

$$-\frac{\partial B}{\partial t} = \nabla \times E$$

Berarti  $B$  tidak bergantung waktu, dengan demikian tidak ada gelombang didalam rongga



## E.1 PANDU GELOMBANG DENGAN PENAMPANG SEGI EMPAT

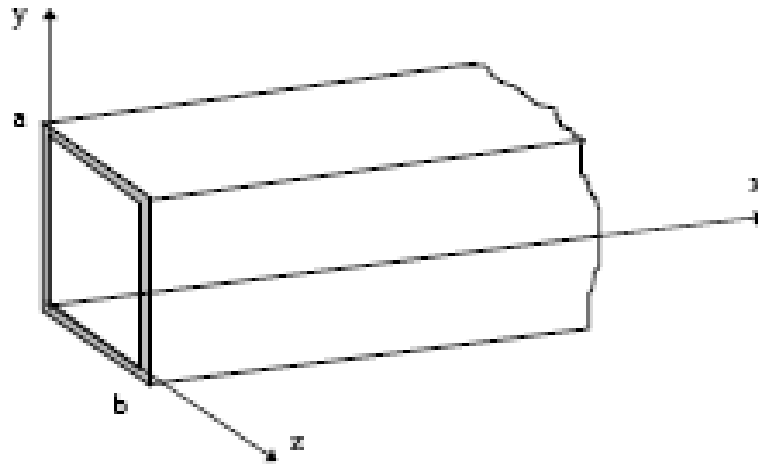

Gambar 6.7  
Pandu gelombang segi empat

Persamaan differensial dari komponen longitudinal

$$\left[ \frac{\partial^2}{\partial y^2} + \frac{\partial^2}{\partial z^2} + \left( \frac{\omega}{c} \right)^2 - k^2 \right] B_x = 0 \quad \dots\dots 1$$



Dan syarat batas  $\hat{n} \cdot B = 0$  dan  $\hat{n} \times B = 0$

Maka dengan pemisalan :  $B_x(y,z) = Y(y)Z(z)$

Substitusikan ke persamaan 1, maka :

$$\left[ \frac{\partial^2}{\partial y^2} + \frac{\partial^2}{\partial z^2} + \left( \frac{\omega}{c} \right)^2 - k^2 \right] Y(y)Z(z) = 0$$

$$Z \frac{\partial^2 Y}{\partial y^2} + Y \frac{\partial^2 Z}{\partial z^2} + \left( \left( \frac{\omega}{c} \right)^2 - k^2 \right) YZ = 0 \quad \text{dibagi } YZ$$

$$\frac{1}{Y} \frac{\partial^2 Y}{\partial y^2} + \frac{1}{Z} \frac{\partial^2 Z}{\partial z^2} + \left[ \left( \frac{\omega}{k} \right)^2 - k^2 \right] = 0 \quad \text{..... 2}$$

$$\text{Sehingga } -k^2 Y - k Z + \left( \frac{\omega}{c} \right)^2 - k^2 = 0 \quad \text{dengan } \frac{1}{Y} \frac{\partial^2 Y}{\partial y^2} = -k^2_y \quad \text{.....3}$$

Solusi dari persamaan 3 :

$$\frac{1}{Z} \frac{\partial^2 Z}{\partial z^2} = -k^2_z \quad \text{..... 4}$$

$$Y = A \sin(k_y y) + B \cos(k_y y)$$



Syarat batas  $\frac{dY}{dy} = 0$  di  $y = 0$  dan di  $y = a$

$\frac{dY}{dy} = k_y A \cos(k_y y) - k_y y B \sin(k_y y)$   $0 = k_y A$ , maka  $A = 0$

$0 = k_y B \sin(k_y a)$  maka,  $k_y a = m\pi$  dengan  $m = 0, 1, 2, \dots$

atau  $k_y = \frac{m\pi}{a}$

Untuk solusi  $\frac{1}{Z} \frac{\partial^2 Z}{\partial z^2} = -k_z^2$  yaitu  $Z = A \sin(k_z Z) + B \cos(k_z Z)$

Syarat batas  $\frac{dZ}{dz} = 0$  di  $z = 0, z = b$

maka  $\frac{dZ}{dz} = k_z A \cos(k_z Z) - k_z B \sin(k_z Z)$  untuk  $\frac{dZ}{dz} = k_z A \cos(k_z Z)$  

Untuk  $\frac{dZ}{dz} = k_z B \sin(k_z Z)$    $k_z B \neq 0$  dan  $k_z z = 0$   $\cos(k_z Z) \neq 0$

$\sin k_z z = 0$  maka  $k_z z = n\pi$  dengan  $n = 0, 1, 2, \dots$   
 $k_z b = n\pi$   
 $z = b$

$k_z = \frac{n\pi}{b}$



maka untuk

$$Y = A \sin(k_y Y) + B \cos(k_y Y)$$

$$= 0 + B \cos\left(\frac{m\pi}{a} y\right)$$

$$= B \cos\left(\frac{m\pi y}{a}\right)$$

$$Z = A \sin(k_z Z) + B \cos(k_z Z)$$

$$= 0 + B \cos\left(\frac{n\pi z}{b}\right)$$

$$= B \cos\left(\frac{n\pi z}{b}\right)$$

Sehingga  $B_x(y, z) = B \cos\left(\frac{m\pi y}{a}\right) \cdot B \cos\left(\frac{n\pi z}{b}\right)$

Untuk mendapat bilangan gelombang k, maka dari persamaan yang sudah didapat

$$-k^2 Y - k^2 Z + \left(\frac{\omega}{c}\right)^2 - k^2 = 0 \quad \text{dengan} \quad k_y = \frac{m\pi}{a} \quad \text{dan} \quad k_z = \frac{n\pi}{b}$$

maka  $-\left(\frac{m\pi}{a}\right)^2 - \left(\frac{n\pi}{b}\right)^2 + \left(\frac{\omega}{c}\right)^2 - k^2 = 0$

$$k^2 = \left(\frac{\omega}{c}\right)^2 - \left(\frac{m\pi}{a}\right)^2 - \left(\frac{n\pi}{b}\right)^2$$

$$k = \sqrt{\left(\frac{\omega}{c}\right)^2 - \left(\frac{m\pi}{a}\right)^2 - \left(\frac{n\pi}{b}\right)^2}$$

$$k = \frac{1}{c} \sqrt{\omega^2 - \omega_{mm}^2}$$

$$\omega_{mm} = \pi c \sqrt{\left(\frac{m}{a}\right)^2 + \left(\frac{n}{b}\right)^2}$$



Untuk mengetahui kecepatan grup maka dapat diperoleh dari persamaan

$$v_g = \frac{d\omega}{dk} \quad v_g = \frac{1}{d\omega/dk}$$

Dari persamaan :  $k = \frac{1}{c} \sqrt{\omega^2 - \omega_{mm}^2}$

$$\frac{dk}{d\omega} = \frac{d}{d\omega} \left[ \frac{1}{c} \sqrt{\omega^2 - \omega_{mm}^2} \right]$$

$$\frac{dk}{d\omega} = \frac{1}{c} \frac{d}{d\omega} (\omega^2 - \omega_{mm}^2)^{\frac{1}{2}}$$

$$\frac{dk}{d\omega} = \frac{1}{c} \frac{1}{2} (\omega^2 - \omega_{mm}^2)^{-\frac{1}{2}} \cdot 2\omega$$

$$\frac{dk}{d\omega} = \frac{\omega}{c} (\omega^2 - \omega_{mm}^2)^{-\frac{1}{2}}$$

$$\frac{dk}{d\omega} = \frac{\omega}{c \sqrt{\omega^2 - \omega_{mm}^2}}$$

$$v_g = \frac{c \sqrt{\omega^2 - \omega_{mm}^2}}{\omega}$$

$$v_g = \sqrt{\frac{\omega^2 - \omega_{mm}^2}{\omega^2}}$$

$$v_g = \sqrt{1 - \left( \frac{\omega_{mm}}{\omega} \right)^2}$$

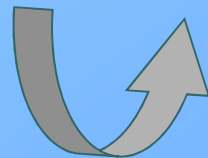

## E.2 PANDU GELOMBANG JALUR

### TRANSMISI KOAKSIAL

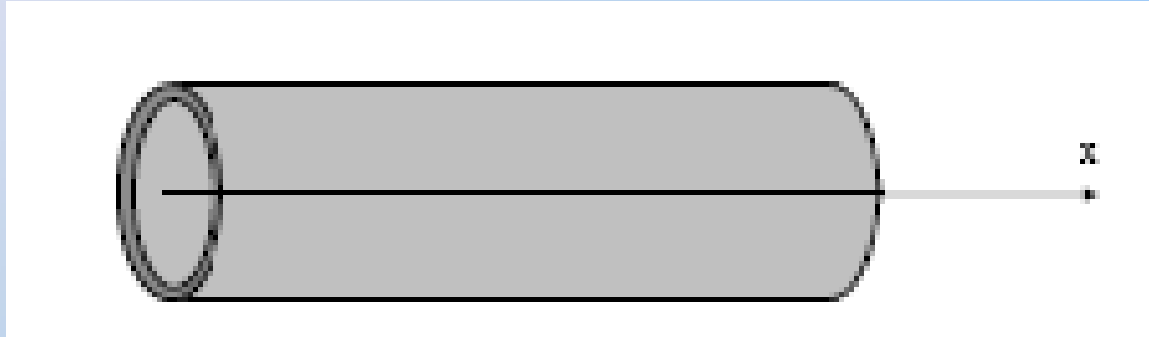

Gambar diatas memperlihatkan pandu gelombang berupa jalur transmisi koaksial (coaxial) transmission line), terdiri dari kawat panjang yang diselimuti konduktor silinder. Kawat panjang itu terletak pada sumbu silinder

Dari persamaan Maxwell 3 dan 4 diperoleh :

$$\frac{\partial B_x}{\partial y} - ikB_y = \frac{i\omega}{c^2} E_z$$

$$\frac{\partial B_x}{\partial z} - ikB_z = -\frac{i\omega}{c^2} E_y$$





● ● ● | Untuk medan listrik :

$$\frac{\partial E_y}{\partial y} + \frac{\partial E_z}{\partial z} = 0$$

$$\frac{\partial E_x}{\partial y} - \frac{\partial E_y}{\partial z} = 0$$

Untuk medan magnet :

$$\frac{\partial B_y}{\partial y} + \frac{\partial B_z}{\partial z} = 0$$

$$\frac{\partial B_x}{\partial y} - \frac{\partial B_y}{\partial z} = 0$$

Maka  $cB_z = E_y$  dan  $cB_y = -E_z$

Solusi dengan menggunakan koordinat silinder

$$E_o = E_o \frac{1}{r} \hat{r} \quad \text{dan} \quad B_o = \frac{E_o}{c} \frac{1}{r} \hat{\Phi}$$

Diasumsikan dalam pandu gelombang benar-benar konduktor sempurna, berlaku  $E = 0$  dan  $B = 0$

Sehingga fungsi gelombangnya

$$E(x, y, z, t) = E_o(y, z) e^{i(kx - \omega t)}$$

$$B(x, y, z, t) = B_o(y, z) e^{i(kx - \omega t)}$$



Untuk persamaan :

$$E(x, y, z, t) = E_o(y, z)e^{i(kx - \omega t)}$$
$$= E_o \cos(kx - \omega t) + \hat{i} E_o \cos(kx - \omega t)$$

Substitusikan  $E_o = E_o \frac{1}{r} \hat{r}$

diperoleh  $E = \frac{E_o}{r} \cos(kx - \omega t) \hat{r}$

Untuk persamaan

$$B(x, y, z, t) = B_o(y, z)e^{i(kx - \omega t)}$$
$$= B_o \cos(kx - \omega t) + \hat{i} B_o \cos(kx - \omega t)$$

yang diambil bagian realnya maka, dengan mensubstitusi

$$B_o = \frac{E_o}{c} \frac{1}{r} \hat{\Phi} \quad \text{maka} \quad B = \frac{E_o}{c} \frac{\cos(kx - \omega t)}{r} \hat{\Phi}$$

